

TK-103

GPS VEHICLE TRACKER USER MANUAL



Preface

Thank you for purchasing our GPS vehicle tracker. This manual shows how to operate the device smoothly and correctly. Make sure to read this manual carefully before using this product. Please note that specification and information are subject to changes without prior notice in this manual. Any change will be integrated in the latest release. The manufacturer assumes no responsibility for any errors or omissions in this document.

Content

1. Summary functions
2. Applications
3. Hardware descriptions
 - 3.1 Front face
 - 3.2 Rear face
 - 3.3 Side face
 - 3.4 Bottom face
4. Specifications
5. Usage

- 5.1 SIM card installation
- 5.2 GPS Vehicle Tracker Installation
- 5.3 Start up
- 5.4 Initialization
- 5.5 Change or resume the password
- 5.6 Authorization
- 5.7 Real-time polling
- 5.8 Auto track
- 5.9 Remote control oil and circuit
- 5.10 Modes switch between “track” and “monitor”
- 5.11 Geo-fence
- 5.12 Movement Alert
- 5.13 Over speed Alert
- 5.14 Restart the tracker
- 5.15 SOS Button
- 5.16 Cut power alert
- 5.17 Set number in a online positioning platform
- 5.18 Mode switch between “telephone” and “web”
- 5.19 GPRS setting
- 5.20 Set time
- 5.20 Set web
- 6 Cautions
- 7 Faults & Solutions

1 Summary function

Working Based on existing GSM/GPRS network and GPS satellites, this product can locate and monitor any remote targets by SMS or GPRS.

1.1 Positioning and Tracking: Through the on-line Positioning Platform or the cell phone to locates at times, and get the working status. You can choose the Positioning Platform by yourself.

1.2 Triggering Emergency Alarm: When there is a emergency happened on the vehicle, you can put on the button and the installed unit will send out alarm to the authorized numbers.

1.3 Remote controlling oil and circuit: you can control the oil and circuit via the unit by SMS in anywhere and anytime.

1.4 Remote Monitoring: In anywhere and anytime, call the phone number in the unit, when it connects, you can monitor the sound around 5 meter.

1.5 Movement Alert: Send SMS to the unit to start the movement alert function. When the vehicle is moving, the unit will send the movement alert to all authorized numbers.

1.6 Over speed Alert: Send SMS to the unit to start the movement alert function. When the vehicle is over speed, the unit will send the over speed alert to all authorized numbers.

1.7 Geo-fence: Set up a geo-fence for the unit to restrict its movements within a district. The unit will send the message to all authorized numbers when it reaches the district.

1.8 The unit: send SMS to resume the default of unit.

1.9 Auto Track: You can set up auto track by SMS or on-line positioning platform.

1.10 Mileage statistics; ACC checking; cutting off power and alarm.

1.11 Compatible with the original anti-theft alarm: It will send SMS alarm after the original anti-theft alarm warning.

1.12 Modify the IP and Port of Communication Protocol for different on-line positioning platform

2. Application

- Vehicle rental / Fleet management etc.
- Protect wealth etc.
- Provide peace-of-mind for businessmen
- Manage personnel

3. Hardware Description

3.1 Side face



3.1 Bottom face



4. Specification

Content	Specifications
Dimension	86mm *63mm *25mm
Weigh	0.51kgs
Network	GSM/GPRS/GPS
Band	850/1800/1900Mhz or 900/1800/1900Mhz or 850/900/1800/190
GPS chip	SIRF3 UBLOX
GSM/GPRS module	Simcom900a or Simcom800w
GPS sensitivity	-159dBm
GPS accuracy	5m
Time To First Fix	Cold status 45s Warm status 35s Hot status 1s
Work voltage	DC10V—36V
Battery	3.7V / 1500mAh
Standby	<50mA
Storage Temp.	-40°C to +85°C
Operation Temp.	-20°C to +70°C
Humidity	5%--95%RH

5. Usage

5.1 SIM card installation

Make sure that there is no call transfer and call display is on, and PIN code off. The SMS message must in Text format, can't be identified for PDU format.

5.1.1 Put SIM card into card box.

5.1.2 Put the card box into host as picture.

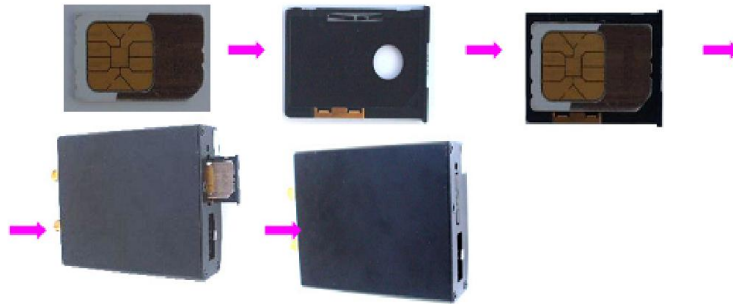

5.2 GPS Vehicle Tracker Installation

GPS/GSM/GPRS tracker should be installed by technical professional of local service centre. Without permission, the user can't repair and move the tracker randomly. If users do, any unfortunate damage should be compensated by him.

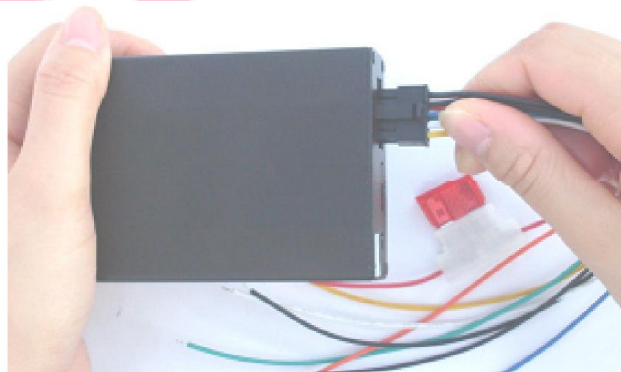

5.2.1 Install Wire Box

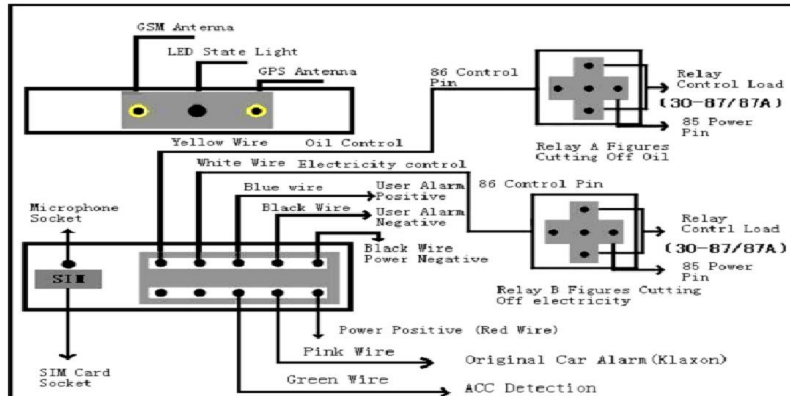

5.2.2 GPS Vehicle Tracker Installation

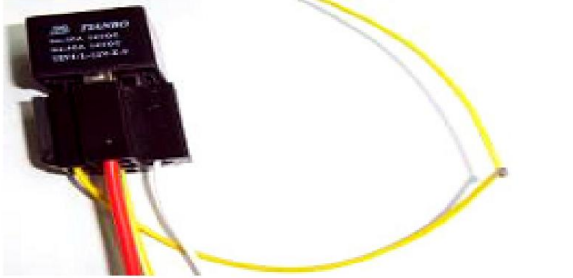

Installation steps (caution: the following installation should under no power, otherwise will be dangerous)

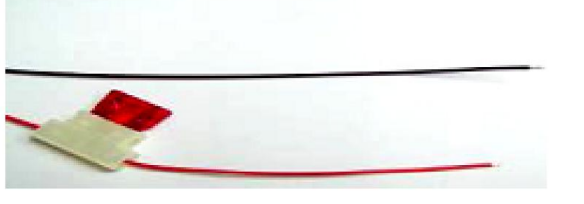
	
<p>Wire for cutting off oil of the tracker Yellow wire connects the relay feet 86; 85 feet to 12 V DC anode, 87A feet and 30 feet in series in the supply oil circuits.</p>	<p>Wire for cutting off circuit of the tracker White wire connects relay feet 86; 85 feet to 12 V DC anode, 87A feet and 30 feet are in series in the supply Power circuits.</p>
	
<p>Emergency triggering alarm The blue wire connects the anode of the alarm button, and the black wire connects the cathode of the alarm button.</p>	<p>Power supply line The red wire connects 12V“+”;Black wire connects to12V“-”</p>

5.3 Start-up

5.3.1 Installed the tracker in the car, then put the SIM card into the tracker host outdoors.

5.3.2 For first use, please initialize the unit and restore it to default setting.(please refer to 5.4 for instruction.)

5.3.3 or 40 seconds, the unit will begin to work and acquire the GSM signals as well as the GPS signals, and the red indicator will keep flashing every 2 seconds when the GPS module is in standby mode. When the blue indicator is keep shine, the unit has been located.

5.3.4 When this unit receives GPS signals normally, you can use it and do all the following settings.

5.4 Initialization

Send "begin+password" in SMS to the unit, it will reply "begin ok" and initialize all the settings. (Default

password: 123456)

5.5 Change the password

5.5.1 Send SMS "password+old password+space+new"password to change the password.

Remark: Make sure the new password is in 6 digits, or else the tracker can not recognize the password.

5.5.2 You can Send "resume+password" to the tracker, to restore the original setting in case of losing the new password.

5.6 Authorization

There are only 4 numbers able to be authorized.

5.6.1 Call the tracker for 10 times, it will make the cell phone number as the authorized number automatically.

5.6.2 Send SMS "admin+password+space+cell phone number" to set up a authorized number. The other authorized numbers should be set by the first authorized number. If the number is successfully authorized, the unit will reply "admin ok!" in SMS.

5.6.3 Send SMS "noadmin+password+space+authorized number"to delete the authorized number.

5.6.4 For roaming purpose, you have to add your country code ahead of the cell phone number, for example,

please "send admin123456 008613311113333"to tracker to set 13311113333 as an authorized number.

5.7 Real-time polling

5.7.1 If there is no authorized number, when any number dials up the unit, it will report a Geo-info; If there is already an authorized number, then it will not respond when an unauthorized number calls it up.

5.7.2 When an authorized number dials up the unit, it will hang up and report a real-time Geo-info as below:

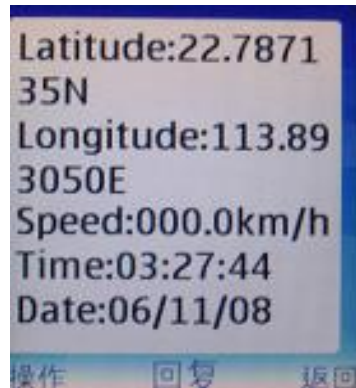

Latitude:22.7871
35N
Longitude:113.89
3050E
Speed:000.0km/h
Time:03:27:44
Date:06/11/08

操作 回复 返回

5.8 Auto Track

Report a Geo-info at 30s intervals to the authorized numbers for 15 times:

5.8.1 Set up: Send SMS "at30sum15 " to the unit, it will report the Geo-info at 30s intervals for 15 times. The setting must be maximum 65535 in value.

5.8.2 Send SMS"at30sum0" to the unit, it will reply SMS heaps of times.

5.8.3 Cancel: Send noat+password to delete the "auto track".

5.9 Remote control oil and circuit

5.9.1 Control oil

Send SMS "stopoil+password" to control oil. For example send SMS:stopoil123456

To supply the oil again, send SMS"supplyoil+password" to the unit.

5.9.2 Control circuit

Send SMS "stopelec+password" to control circuit. For example send SMS: stopelec123456

To supply the circuit again, send SMS"supplyelec+password" to the unit.

If there is no authorized number, all number can control. If there is already an authorized number, only the authorized number can control.

5.10 Modes switch between "tracker" and "monitor"

5.10.1The default mode is "tracker".

5.10.2 Send SMS "monitor+password" to the unit, and it will reply "monitor ok!" and switch to "monitor" mode.

5.10.3 Send SMS "tracker+password"to the unit, it will reply "tracker ok!" and restore to "track" mode.

5.11 Geo-fence

Set up a geo-fence for the unit to restrict its movements within a district. The unit will send the message to the authorized numbers when it breaches the district.

5.11.1 Set up: When the unit stays immobile in a place for 3-10 minutes, the user can Send SMS "**stockade+password+space+longitude,latitude;longitude,latitude**" to unit to set the restricted district. In case of breach, it will send SMS "stockade!+geo-info" to the authorized numbers.

Remark : The first longitude& latitude is coordinate of the top left corner of the Geo-fence, while the second longitude&latitude is the coordinate of the bottom right corner. It will alarm one time in each setting.

5.11.2 Cancel: Send SMS "nostockade+password"to deactivate this function.

This function will be out of effect after the unit moves outside the district.

5.12 Movement alert

5.12.1 Set up: When the unit stays immobile in a place for 3-10 minutes, the user can send SMS "move+password"to the unit, then the unit will reply "move ok!". In case of such a movement, it will send SMS "Move" along with a Geo-info to the authorized numbers. It will alarm one time in each setting.

5.12.2 Cancel: Send SMS "nomove+password"to deactivate the movement alert.

Remark: This function will be out of effect after the unit moves outside the district.

5.13 Over speed alert:

5.13.1 Set up: Send SMS "speed+password+space+080"to the unit (suppose the speed is 80km/h), and it will reply "speed ok!". When the target moves exceeding 80 km/h, the unit will send SMS "speed+080!+Geo-info" to the authorized numbers. It will alarm one time in each setting.

5.13.2 Cancel: Send SMS nospeed+password to deactivate the over speed alert

5.14 Restart the tracker.

Send SMS "reboot+password" to the tracker. For example"reboot123456".The tracker will be restarted.

5.15 SOS button

Press the SOS for 3 second, it will send "help me !+ Geo-info" to all the authorized numbers every 3 minutes. It will stop sending such a SMS when any authorized number reply SMS "help me !+ Geo-info" to the tracker.

5.16 Cut power alert

If cut power,the unit will send SMS alert. SMS format: " Cut power Alert+Geo-info".

5.17 Set number in a online positioning platform Add the number on the online positioning platform for tracking. Adding to the special platform, send SMS "number+tracker number"to the tracker.

for example "number13500001111". need the platform have the fuction.

5.18 Modes switch between "telephone" and "web"

5.18.1 For sending GPS data to IP address:Set up: Send SMS "web + password"to device.if set successfully, the device will reply SMS "setweb ok". After this, you can call the tracker. The tracker will hang up the phone and report the GPS data to IP address.

5.18.2 For sending GPS data to telephone:

Set up: Send SMS "telephone + password" to device.

if set successfully, the device will reply 'set telephone ok'.

And then, the device will send GPS data to your telephone by SMS.

Remark: The default is sending the GPS data to the telephone.

5.19 GPRS setting

In order to use GPRS function, the user needs to set IP, Port and APN (access point name) by sending SMS commands.

5.19.1 Set an IP address and port:

The IP address and port of Communication Protocol in the tracker can be modified and transferred data to other platform. Send SMS "IP address+port number" to the unit. If the tracker's IP address and port should be modified to 19.147.23.100and 2332, send SMS "ip 119.147.23.100port2332"to the tracker.

5.19.2 Set APN

In order to send GPS data to IP address, you still must set mobile network Access Point Name (APN). If you don't know the APN, you can consult local network service supplier. The format of set APN is "apn +password +space + APN". For example you send SMS "apn123456 cmnet" to the device. The device will reply SMS "Set APN ok. " .

5.20 Set Time

In order to make the time as the same with the user country, please send SMS command "zone123456 space time zone". For example, if user country time is GMT+8,then send"zone123456 8"to the device. If user country time is GMT-6,then Send "zone123456 -6"to device. The device will reply SMS "set time zone ok".

5.21 Set Web

In order to see your website in each replying SMS ,For example you website is www.webs***.com, then send "home123456 www.webs***.com" . Then it will reply "set

home ok" ,when you want to cancel it, just send "nohome123456",it will reply SMS "cancel home ok".

6 Cautions

6.1 Make sure to read this manual carefully before using this product.

6.2 Please insert the SIM card before installing, and make sure the SIM card has no password, otherwise the tracker will not work normally.

6.3 The tracker's work voltage is 10V-36V. Please use the tracker in the scope of work voltage.

6.4 Please make sure that all the cables of the tracker has been connected rightly, and then connect the tracker to host power.

6.5 The tracker works in wireless communications, to avoid electromagnetic interference or incompatible configuration, please stop using your tracker in the noticed place.

6.6 Keep the unit dries. Any liquid, i.e. rain, moisture, may destroy or damage the inside circuitry.

6.7 Clear the unit with a piece of dry cloth. Don't clean in chemicals or detergent.

7. Faults & The solutions

Faults	Solution
Start up Fail	Check the battery and see if it is fully charged or correctly installed.
Hang up Fail	In existence of an authorized number, an unauthorized number dials up the unit. Please initialize the unit and re-set up the authorized numbers.
Monitor Fail	Check if the authorized number is setup or in the coverage of signals.
Location report in digits of zeros	Don't use it in the place beyond reach of signals. Place the unit outdoors, especially when starting it up.